

PITT
COOKING

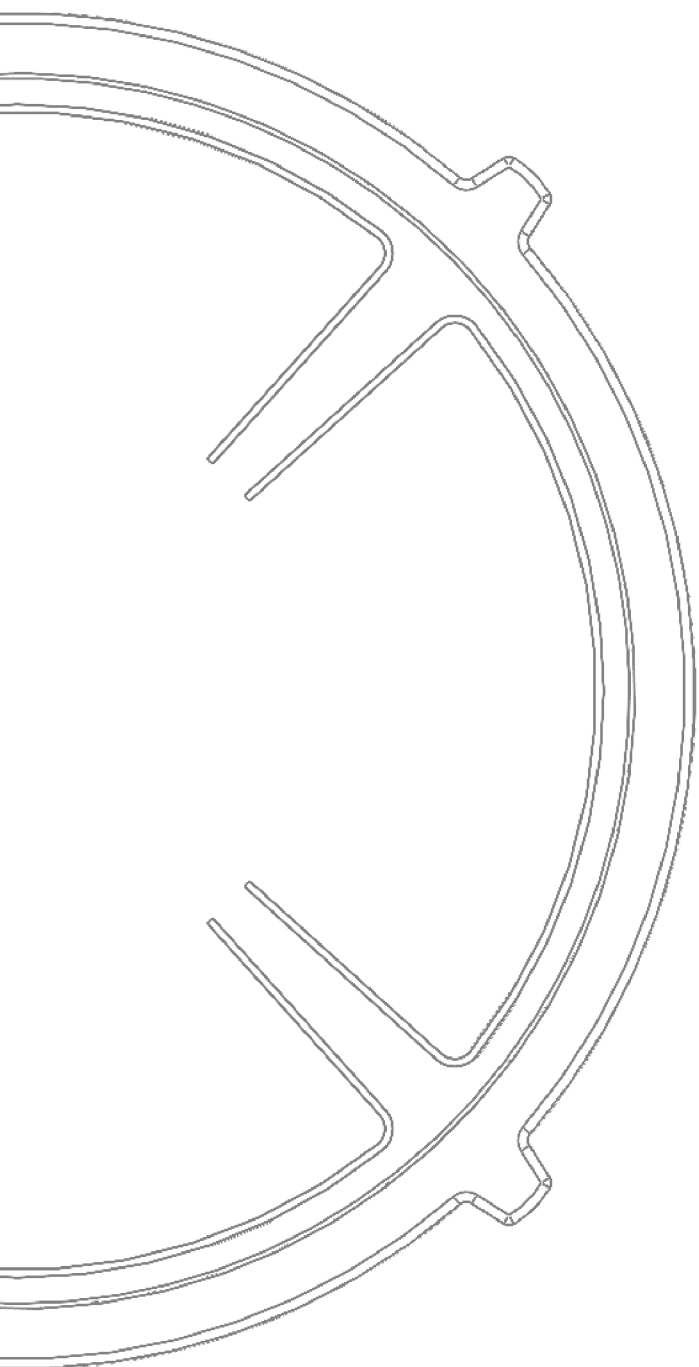

EN User Manual

Top Side/Front Side

Contents

Chapter	Subject	Page
1	Installation Dimensions	3
2	General Information and Safety	4
3	Connection	7
4	Description of the Appliance	9
5	Using the Cooktop	10
6	Top Side models overview	13
7	Front Side models overview	15
8	Packaging	16
10	Maintenance	17
11	Troubleshooting	17
11	Service Address	19

Introduction

EN

Dear Customer,

Congratulations on purchasing your PITT® cooking induction cooktop. This unique system allows you to choose the placement of each cooking zone, ensuring you enjoy your appliance for many years. With its various zone capacities, you can prepare every dish perfectly.

This manual explains how to make the most of all the features of your cooktop. We recommend reading both the user manual and installation instructions carefully before using the appliance.

Please keep this manual in a safe place for future reference, and for any service needs that may arise.

We wish you many enjoyable cooking experiences!

PITT® Cooking

1 Installation dimensions

Top Side (TS) Hole Pattern Kitchen Worktop

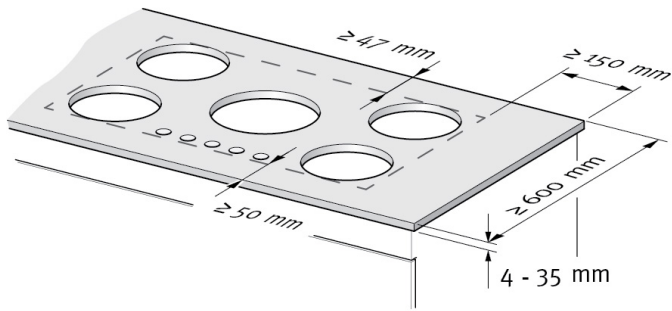

fig. 1

Front Side (FS) Hole Pattern Kitchen Worktop

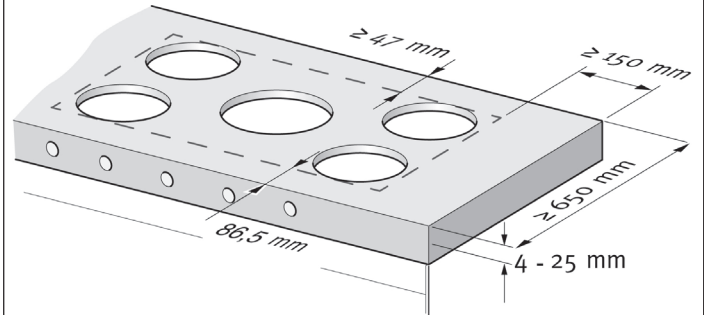

fig. 2

Height of cooking appliance (TS and FS)

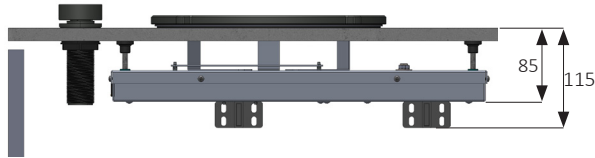

fig. 3

*dimensions in mm

Height of extractor hood or kitchen cabinet (TS and FS)

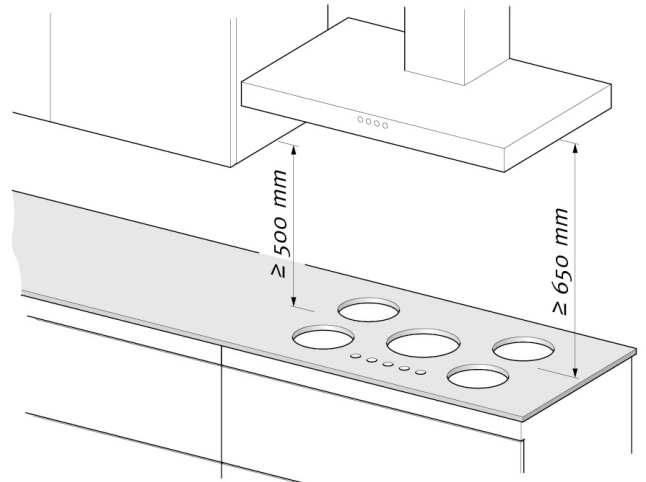

fig. 5

Support set placement (TS and FS)

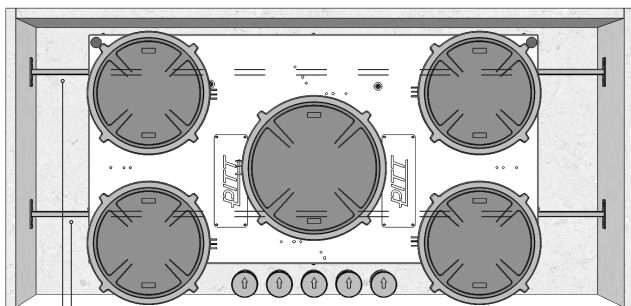

fig. 4 Support beam

*The support set consists of two support beams

- Necessary precautions must always be taken when installing the induction cooktop (see figs. 1, 2, and 5).
- A PITT® cooking module must never be mounted over the seam between two cabinets. The cooktop must always be removable for service.
- When planning to install the PITT® cooking module above a drawer, account for the total thickness of the unit and support set, which is 115 mm (Top Side and Front Side), measured from the top of the countertop (see fig. 3).
- To prevent bending of the kitchen countertop, the cooktop must be supported with the PITT® cooking support set (see figs. 3 and 4).
- Ensure that there is a minimum gap of 6 mm between the front edge and the underside of the countertop. This gap must also be maintained at the rear to ensure proper ventilation (see fig. 6).

Minimum ventilation height (TS and FS)

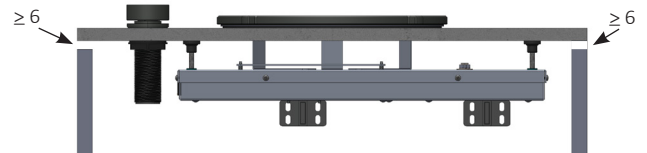

fig. 6

*Dimensions in mm

2 General Information and Safety

General

This cooktop complies with current safety regulations. However, improper use can result in personal injury or material damage. Carefully read all relevant manuals before using the cooktop. They contain important instructions regarding installation, safety, use, and maintenance. This ensures your safety and helps prevent damage to the cooktop.

If safety guidelines and warnings are not followed, PITT® Cooking cannot be held liable for any resulting damage. Keep the user and installation manuals and pass them on to any future owners.

Safety

Hot Components

1. The cooktop and the countertop around the cooking zones become hot during use and remain hot for a significant time after cooking. Avoid touching these hot parts.
2. Overheated oil or butter can easily catch fire. Never extinguish with water. You can smother the flames by covering the pan with a lid.
- 3. Fire Hazard: Do not store items on the cooking surfaces.**
4. Never flambé under a range hood, as this can cause a fire.
5. Do not place a grill or baking sheet over one or two cooking zones.
6. Do not use pans with a bottom diameter larger than the diameter of the ceramic glass.
7. Using pans with a larger bottom diameter than recommended can cause the control knobs to become hot during prolonged and intensive use.
- 8. Do not place (metal) objects (such as cutlery and pot lids) on the cooking zones. When the system is on or still hot, metal objects can become hot, and other materials can melt or catch fire.**
9. Never place hot objects on or near the control knobs. The underlying electronics can overheat.
- 10. WARNING: Unattended cooking with fat or oil on a cooktop can be dangerous and may lead to fire. Never attempt to extinguish a fire with water; turn off the appliance and cover the flames with a lid or a fire blanket.**
11. Due to the rapid operation of induction cooking, the temperature in the pan can rise very quickly, causing oils and fats to ignite.
12. Unattended cooking with fat or oil on a cooktop can be hazardous and cause fire.
13. Never use the booster function when heating fats and/or oils.
14. When the cooktop is used for long periods and intensively, metal objects in the drawer under the cooktop can become hot. Acidic foods, such as vinegar, jam, or lemon juice, can cause discoloration of the ceramic plate. Remove acidic foods immediately.

EN

Technical Safety Instructions

1. The warranty will be void if the cooktop is repaired by a non-authorized technician from PITT® Cooking.
2. A damaged appliance can pose a safety risk.
3. Do not use the cooktop if it is damaged; have it repaired by an authorized technician. Regularly check the product for damage.
4. The electrical safety of the cooktop is only guaranteed if it is connected according to current regulations. If in doubt, have the electrical installation inspected by a qualified professional.
5. Only use the cooktop if it has been installed and built in according to the instructions.
6. It is dangerous for the user to touch parts that are live. This can also lead to improper functioning of the cooktop.
7. Defective parts should only be replaced with original PITT® Cooking parts.
8. The cooktop should not be used with an external timer or a remote control system.
9. If the connection cable is damaged, it must be replaced with a prescribed connection cable by an authorized electrician from PITT® Cooking.
10. If the power cord is damaged, it should be replaced by qualified professionals to prevent danger.

2 General Information and Safety

Responsible usage

1. The PITT® cooking cooktop is intended for household use only.
2. Use the cooktop solely for preparing food. The appliance is not suitable for heating spaces. Use for other purposes is not permitted.
3. Ensure that all product components are installed as indicated.
4. Ensure adequate ventilation during use. If there is a drawer located beneath the cooktop, make sure there is sufficient space underneath it.
5. This appliance may only be used by individuals who are capable of operating it safely. These individuals must be fully informed about the contents of the user manual and aware of the dangers associated with improper use.
- 6. This appliance is not intended for use by individuals (including children) with reduced physical, sensory, or mental capabilities, or those lacking experience and knowledge, unless they are supervised or have received instructions on how to use the appliance from a person responsible for their safety.**
- 7. Children should be supervised to ensure they do not play with the cooktop.**
8. The cooktop is not suitable for use at altitudes above 2000 meters (measured from sea level).
- 9. WARNING: The cooking process must be supervised. Short cooking processes should be monitored continuously.**
10. Never flambé under a range hood. The flames can cause the range hood to catch fire.
11. Never heat pans without contents. The cooking zone can be damaged by dry heating pans.
12. Do not use the appliance to can or heat food in sealed cans or similar containers.
13. Never cover the cooktop with, for example, a cover plate, protective film, or cloth.
14. Never use the cooktop as a work surface.
- 15. After use, turn off the cooktop element with the controls and do not rely on the pan detector.**
16. Always use dry, heat-resistant gloves or oven mitts while cooking.
17. The connection cable of an electronic device should not come into contact with the cooking zones. The insulation of the connection cable can be damaged by the heat.
18. Do not let objects fall onto the cooking zone. If objects or food fall onto the hot cooktop and melt, the cooking zone may be damaged during cooling. In such cases, turn off the appliance immediately and thoroughly remove the remnants. Follow all safety and maintenance instructions for this.
19. The electromagnetic field of the activated cooktop can affect the operation of magnetizable objects. Keep credit cards, storage media, calculators, etc., away from the activated appliance.
20. For individuals with a pacemaker: An electromagnetic field is generated around the activated cooktop. For safety, consult your doctor or pacemaker manufacturer to ensure safe use.
21. Granules such as sugar, salt, or sand (e.g., from vegetables) can scratch the cooking zone. Ensure the bottom of the pan is always clean before placing it on the cooking zone.
22. A rough pan bottom can damage the cooking zone. Always use pans with a smooth, flat bottom.
23. Do not slide a pan on the cooking zone; lift the pan when moving it. This helps prevent possible damage.
24. Do not use induction adapter plates. Adapter plates can damage the induction generators.
- 25. WARNING: Turn off the appliance if the surface is cracked to prevent the risk of electric shocks.**
- 26. Do not use a steam cleaner to clean the cooktop. Steam can cause short circuits or material damage.**
- 27. The appliance is not intended to be operated with an external timer or a separate remote control. The control panel should only be connected to the prescribed heating units to avoid potential hazards.**
- 28. Only the supplied control knob(s) should be connected to the PITT® cooking cooktop. Non-matching control knobs should not be connected to prevent potential danger.**

2 General Information and Safety

Use of Correct Pans



Inductie geschikt

Check de **onderkant** van de pan. Als dit "**inductie**" **symbool** op de panbodem vermeld staat, dan is deze pan geschikt voor inductie.

~~Koper~~
~~Aluminium~~
~~Glas~~

Pannen gemaakt van glas, volledig koper of aluminium zijn **niet** geschikt voor inductie.

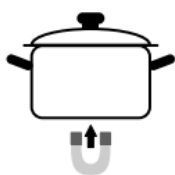

De panbodem moet gemaakt zijn van **magnetiseerbaar materiaal**. Je kunt dit testen met een magneet. Deze magneet moet zich aan de bodem hechten. Als dit niet lukt, dan is de pan niet geschikt.

RVS &
Gietijzer

RVS pannen zijn vaak voorzien van een speciale bodemconstructie en daardoor **meestal** geschikt voor inductie. Check voor alle zekerheid altijd of het **inductie symbool** (zie hierboven) op de panbodem vermeld staat!

Let op
de
diameter

De pan moet een diameter hebben die **kleiner/gelijk** is dan de diameter het kookveld waarop je dit pan wilt gaan gebruiken. De grote PITT inductie brander/kookzone heeft een glasplaat met een diameter van Ø 24 cm; de kleine brander/kookzone heeft een diameter van Ø 20 cm

Vlakke
bodem!

De panbodem moet **vlak** zijn en er mogen geen diepe **groeven** in de bodem lopen.

3 Connection

Electrical Connection Instructions

1. Installation, maintenance, and/or repair work must only be carried out by a PITT® cooking authorized technician. Incorrectly performed work can pose significant risks to the user.
2. The cooktop must be connected to the electricity supply by an electrician.
3. The connection data displayed on the type plate must match the values of the electricity supply. If in doubt, consult a certified electrician.
4. During installation, maintenance, and repair work, the cooktop must be completely disconnected from the electricity supply. Follow these steps:
 - Turn off the circuit breakers in your fuse box, or
 - Completely remove the fuses from your fuse box, or
 - Unplug the plug (if present) from the outlet. Pull on the plug and not on the connecting cable.
 If no plug is present, the connection must be disconnected in accordance with wiring regulations.
5. Never connect the cooktop using power strips or extension cords.



Electrical Connection Requirements | 220-240 VAC

⚠ IMPORTANT: The diameters of the wires in the connection cable must be at least **2.5 mm²**. The maximum length of the connection cable is **1500 mm**.

MODEL:	Max. vermogen	220 - 240 VAC
AKAN-I	2100 Watt	Schema 1
AZUMA-I	3000 Watt	
BAULA-I; BELY-I; BALURAN-I; BENNETT-I; BALUT-I	3680 Watt	
BROMO-I; CUSIN-I; COLO-I; CAPITAL-I CIMA-I; DANAU-I; DEMPO-I; ;DRUM-I	5750 Watt	Schema 2

EN

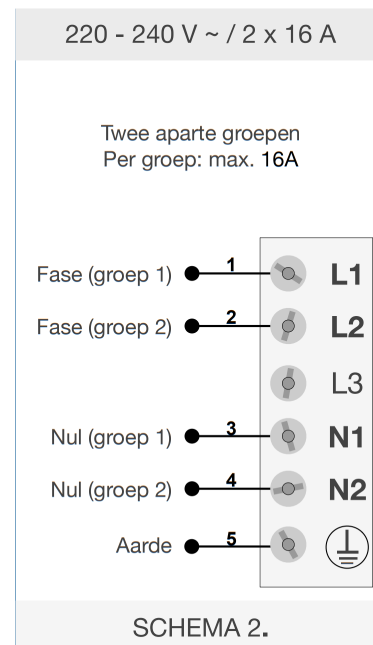
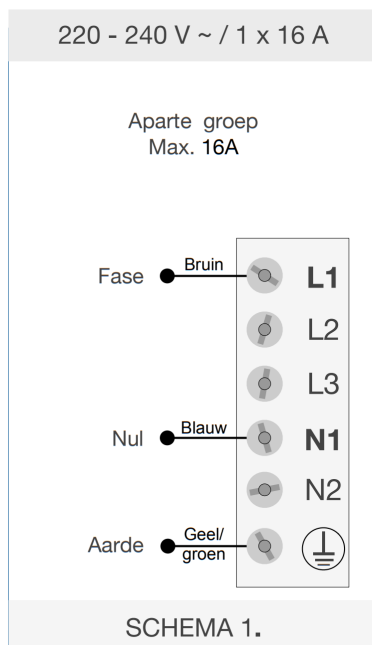

3 Connection

Electrical Connection Requirements | 380-415 VAC

⚠ IMPORTANT: The diameters of the wires in the connection cable must be at least **2.5 mm²**. The maximum length of the connection cable is **1500 mm**.

MODEL:	Max.. vermogen	380 - 415 VAC (3 fasen)
AKAN-I	2100 Watt	Schema 1
AZUMA-I	3000 Watt	
BAULA-I; BELY-I; BALURAN-I BENNETT-I; BALUT-I	3680 Watt	Schema 1
BROMO-I	6000 Watt	Schema 3
CUSIN-I; COLO-I	6680 Watt	Schema 4
CAPITAL-I; CIMA-I	6680 Watt	Schema 3
DANAU-I; DEMPO-I; DRUM-I	7380 Watt	Schema 4
EBEKO-I; ELBRUS-I; ENEP-I	10360 Watt	Schema 5
FOESSA-I	11040 Watt	Schema 5

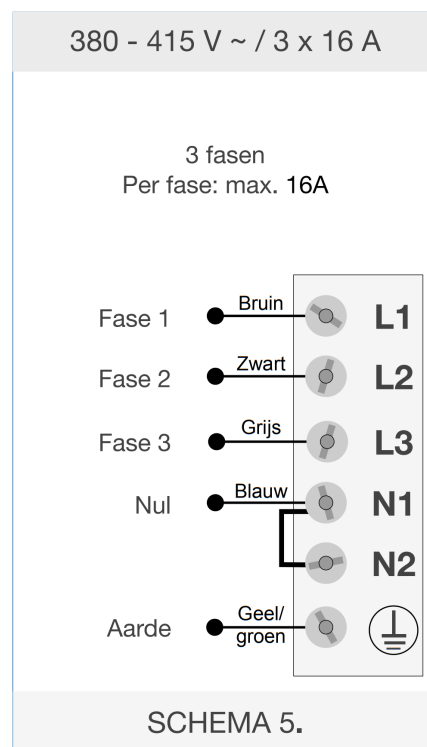
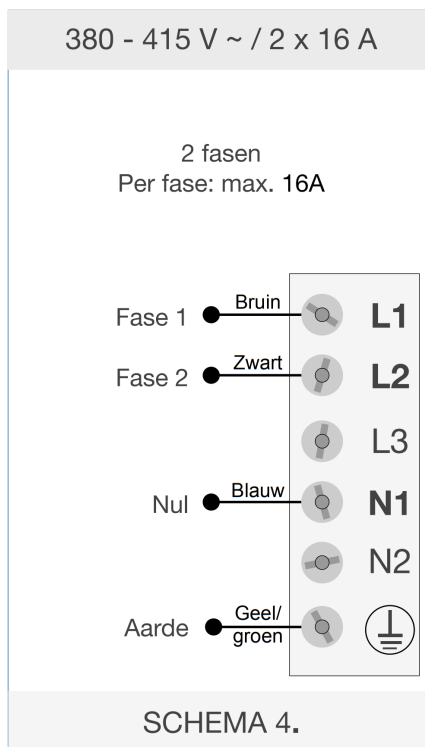
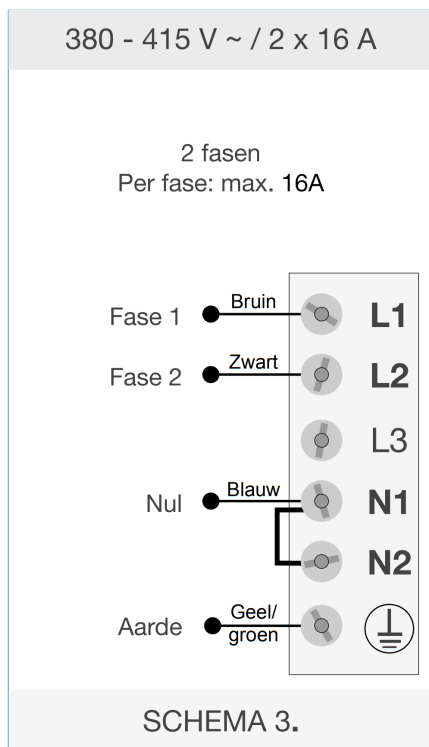

4 Description of the Appliance

Components of the Control Knob

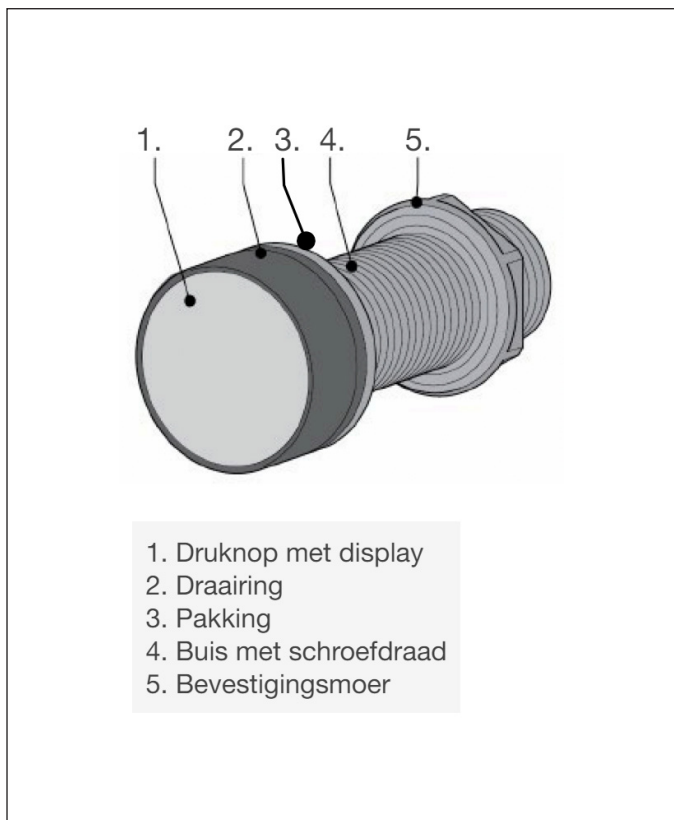

Physical Functions of the Control Knob

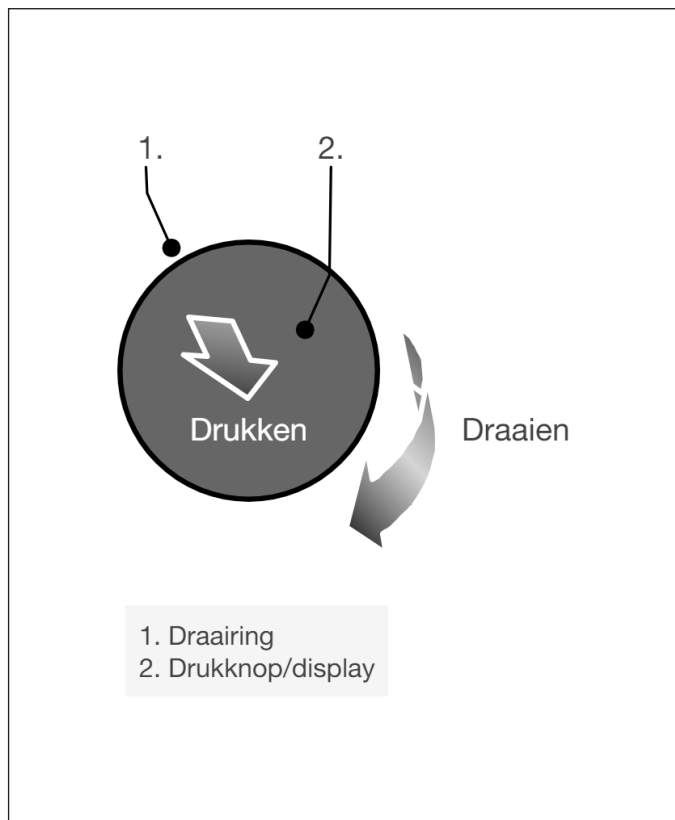

Indication

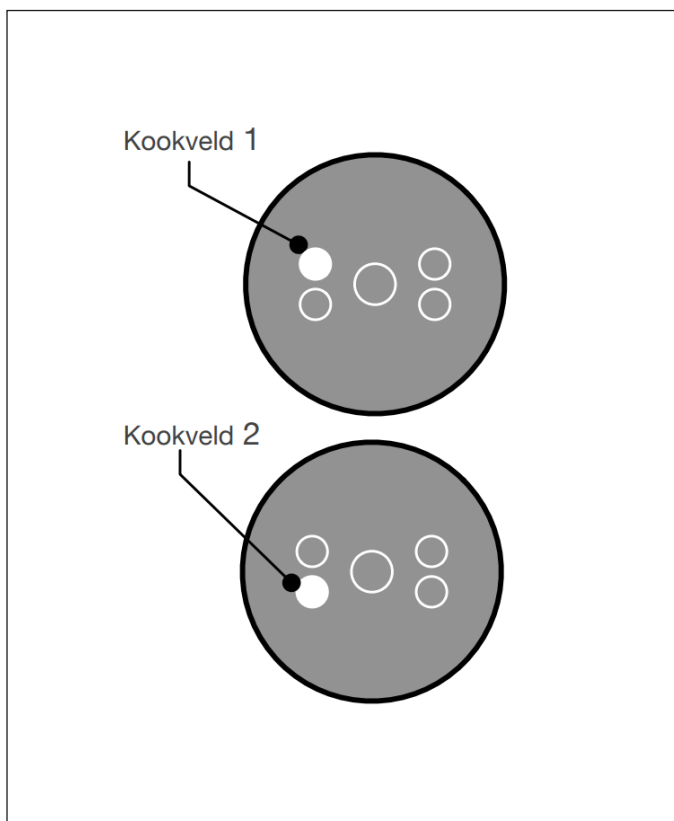

Indication cooking fields

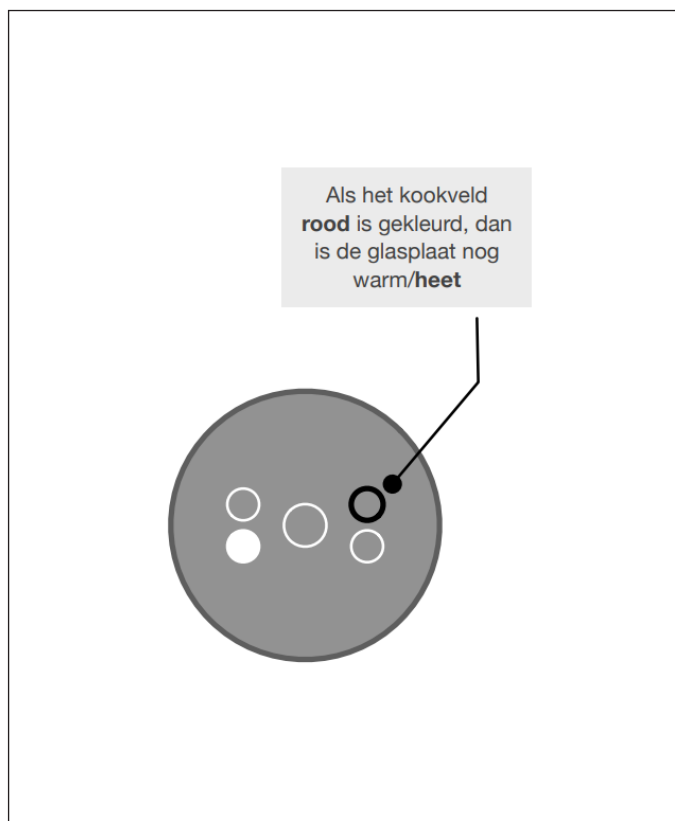

EN

5 Using the cooktop

Turning on the system

1. Press any button to turn on the system.

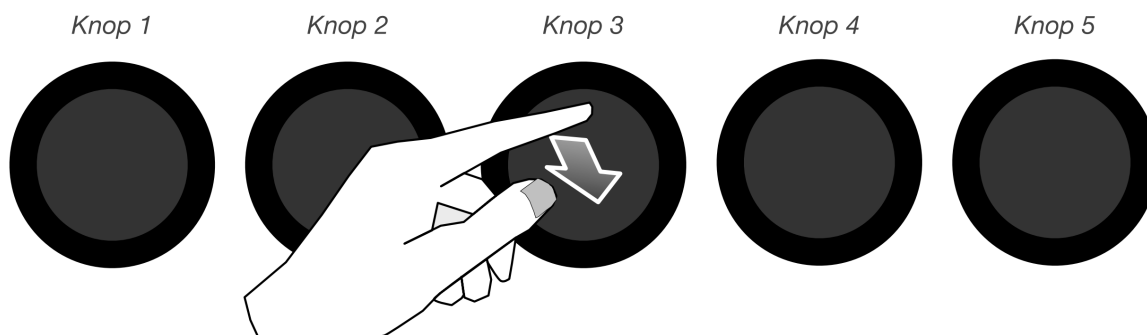

2. The system is turned on and ready for use. The logo disappears.

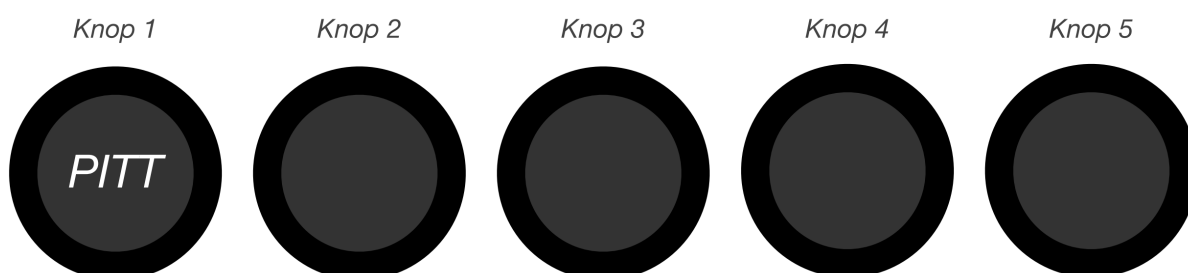

3. The control knobs indicate the position of the cooking zone for each respective knob.

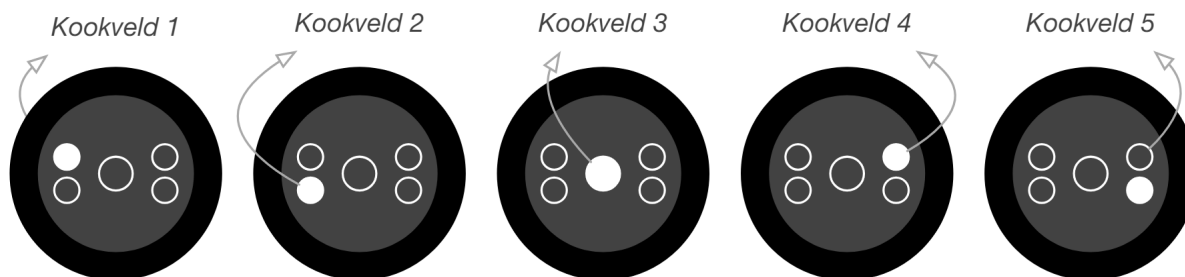

5 Using the cooktop

Activating a Cooking Zone

1. Place a pan on the desired cooking zone. Press the corresponding button to activate it.



2. Turn the knob clockwise.

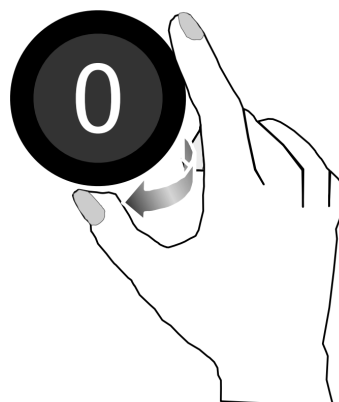

3. The cooking zone is activated starting from power level '1'.



4. Turn the knob until the desired power level is set.



EN

Indicator of Control Knob and Cooking Zone at Active Power Level

1. Press the button to display the corresponding cooking zone. The indication of the cooking zones will disappear after a few seconds.

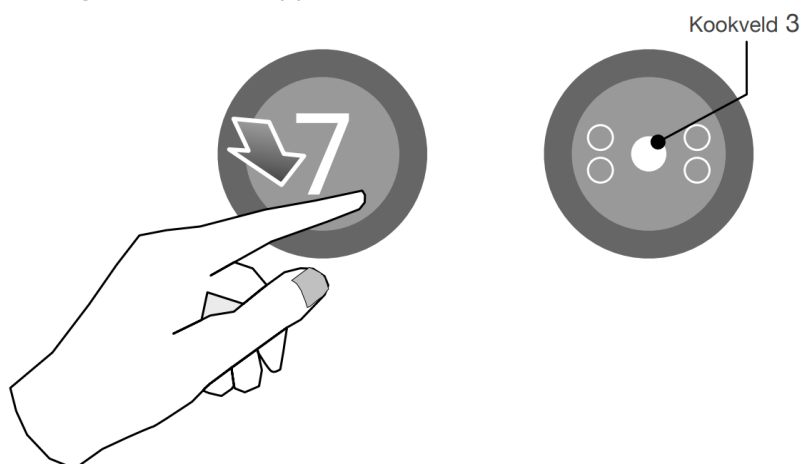

5 Using the cooktop

Activate/Deactivate Child Lock

1. Press the control knob twice briefly to activate the child lock.

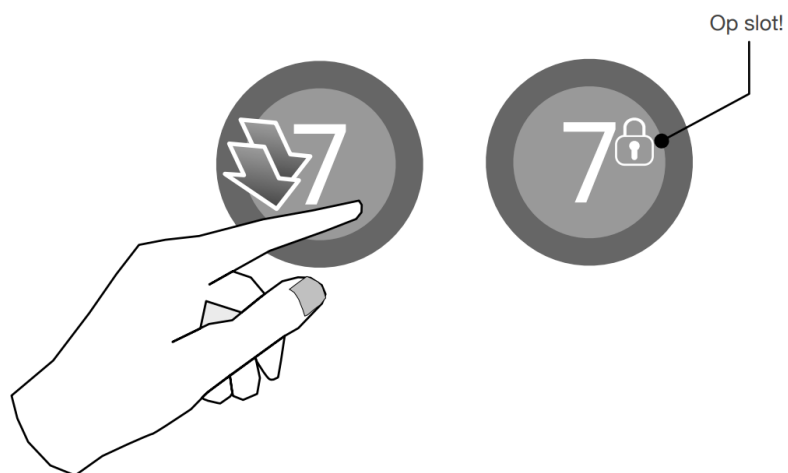

2. When the child lock is active, press the control knob twice briefly to **deactivate** the child lock.

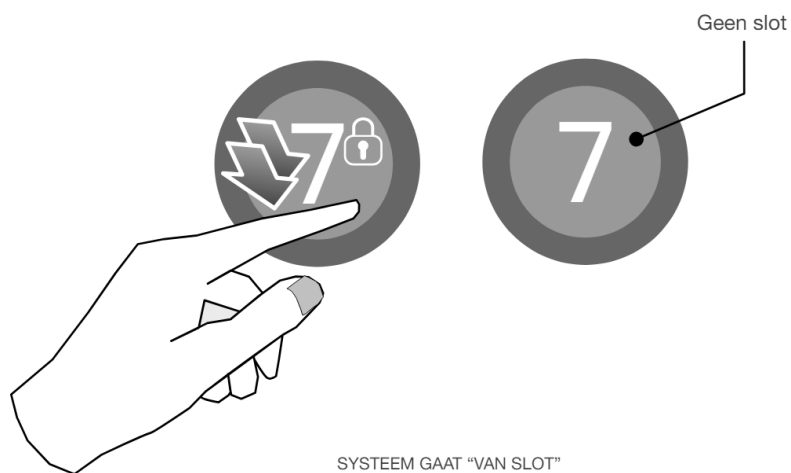

SYSTEEM GAAT "VAN SLOT"

EN

Power Levels and Boost Function

1. Power levels can be set between 1 and 10. The 'boost' mode follows after power level 10.

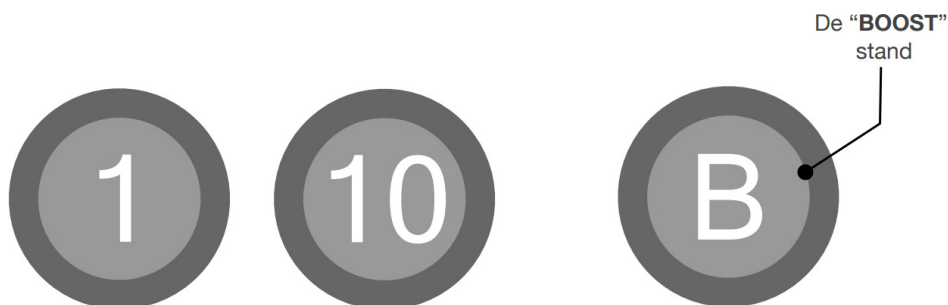

6 Top Side models overview

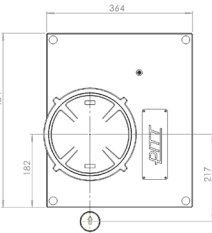
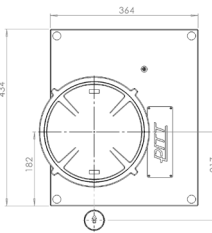
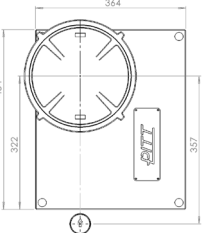
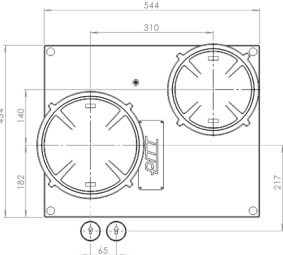
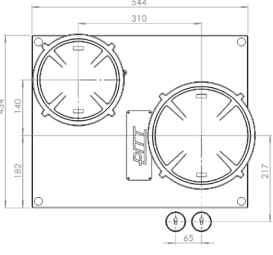
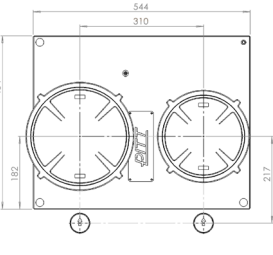
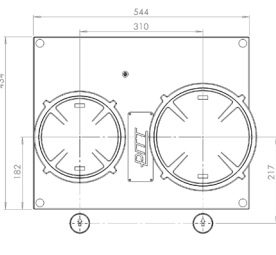
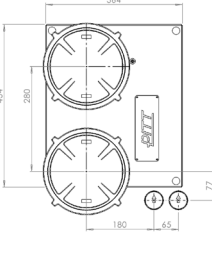
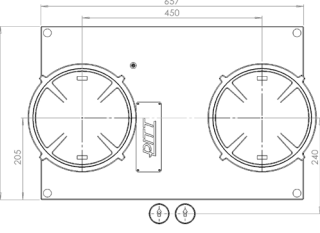
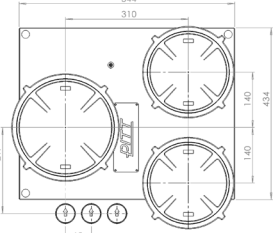
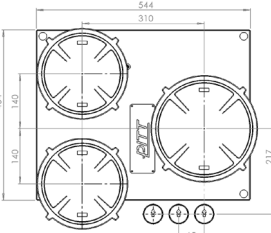
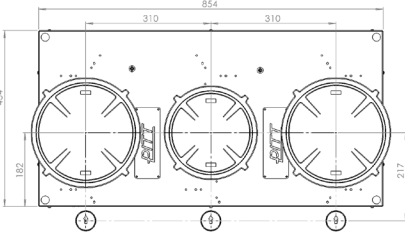
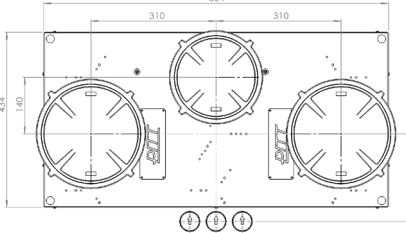
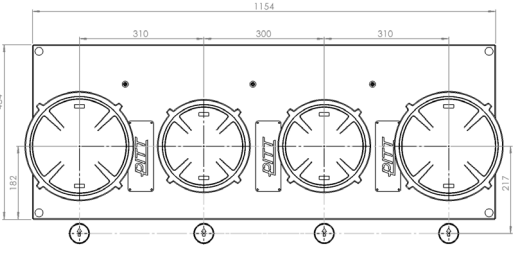
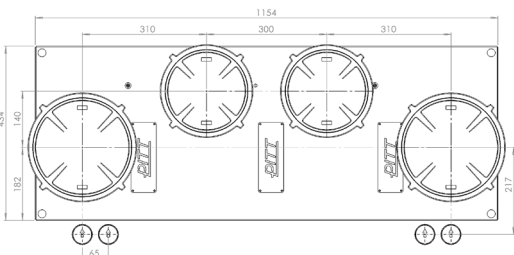
<p>Akan-I</p> 	<p>Azuma-I</p> 	<p>Air-I</p> 	<p>Baluran-I</p> 
<p>Bennett-I</p> 	<p>Baula-I</p> 	<p>Bely-I</p> 	<p>Bandai-I</p> 
<p>Bromo-I</p> 	<p>Cima-I</p> 	<p>Capital-I</p> 	
<p>Cusin-I</p> 	<p>Colo-I</p> 		
<p>Danau-I</p> 	<p>Drum-I</p> 		

EN

6 Top Side models overview

Dempo-I

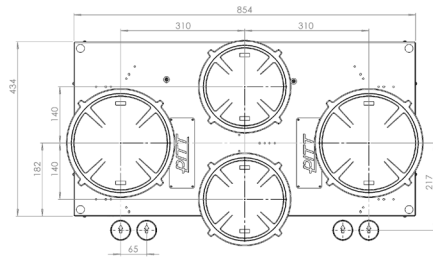

Elbrus-I

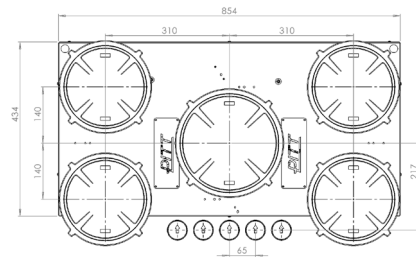

Enep-I

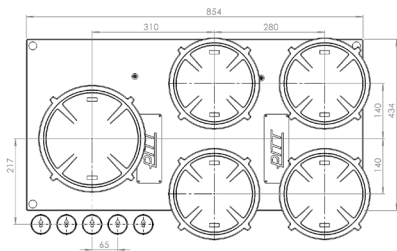

Ebeko-I

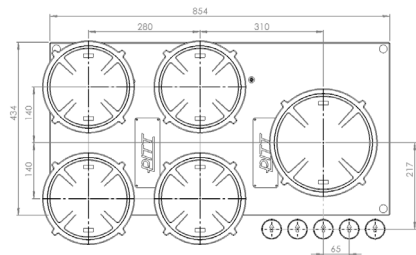

Foessa-I

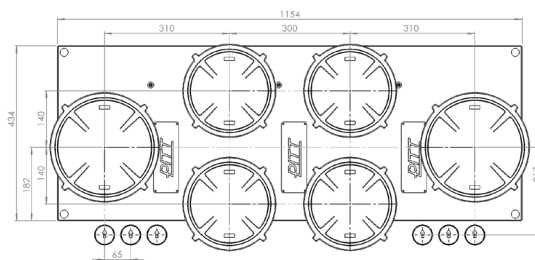

7 Front Side models overview

<p>Akan-I</p>	<p>Azuma-I</p>	<p>Air-I</p>	<p>Baluran-I</p>
<p>Bennett-I</p>	<p>Baula-I</p>	<p>Bely-I</p>	<p>Bandai-I</p>
<p>Bromo-I</p>	<p>Cima-I</p>	<p>Capital-I</p>	
<p>Cusin-I</p>	<p>Colo-I</p>		
<p>Danau-I</p>	<p>Drum-I</p>		

EN

7 Front Side models overview

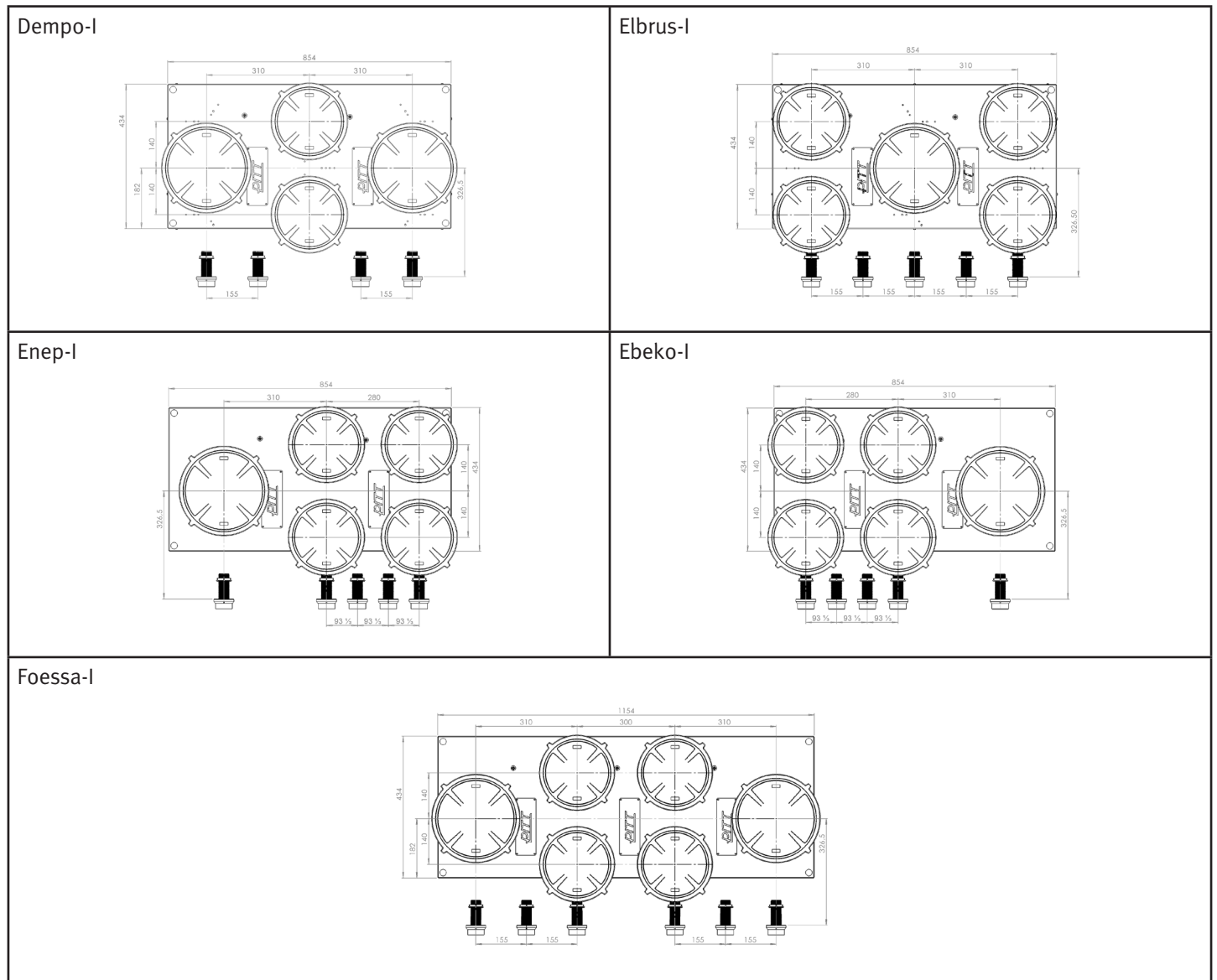

8 Packaging

The PITT® cooking system is manufactured using durable materials.

The packaging is recyclable and consists of the following materials:

- Cardboard
- Paper

These materials should be disposed of responsibly according to government regulations. The packaging of this product features a sticker with an image of a crossed-out trash bin (see image 9).



The European Union's Waste Electrical and Electronic Equipment (WEEE) Directive requires that products sold in EU countries (or in some cases their packaging) be labeled with a crossed-out trash bin symbol. As stipulated by the WEEE Directive, this symbol indicates that customers and end-users in EU countries must not dispose of electrical and electronic equipment or accessories with household waste. Customers and end-users within the EU should contact their local supplier or service center for information on waste collection systems in their municipality.

9 Maintenance of the PITT® Cooking System

The PITT® cooking system is made from high-quality materials that are easy to clean.

Please note the following points:

1. Never clean parts in the dishwasher; dishwashing detergent can damage them.
2. Avoid excessive moisture during cleaning; it can reach unwanted areas.
3. Place the decorative rings directly on the cook zones; do not slide them across your work surface.
4. Pay attention to the guide pins when assembling the decorative ring.
5. Clean the cooktop immediately after use to prevent overcooked food from setting and becoming difficult to remove. Be aware that the parts may be hot after use! ●
6. Start by cleaning the knobs, cook zones, and decorative ring, then clean the work surface to prevent recontamination.
7. Use a mild cleaning agent and a soft cloth to clean the removable decorative ring. Stubborn stains on the ring are best removed with a liquid cleaner.
8. Do not use abrasive powders, scouring pads, sharp objects, or aggressive cleaning agents.
9. For maintenance and cleaning of your work surface, refer to the manual of the respective product.

Note: The PITT® cooking system must not be cleaned with steam or high-pressure cleaners. Using such methods can compromise electrical safety.

10 Troubleshooting the PITT® Cooking System

Note: The PITT® cooking system should only be installed by a certified installer. To ensure safety and maintain the warranty, repairs must be carried out exclusively by authorized professionals. Only use original parts.

Here is an overview of possible faults:

- Ox.. (e.g., '0x21' or '0x32')
- Eb.. (e.g., 'Eb3 images')
- Ep.. (e.g., 'Ep1 buttons')

If any of these codes appear on one of the control buttons, we recommend contacting your dealer or the PITT® cooking customer service as soon as possible. See the contact information on the last page (back side).

EN



Made in Holland

PITT® cooking Nederland
Damzigt 54
3454 PS De Meern
The Netherlands

T: +31 (0)88 088 70 70
www.pittcooking.com